

Product Guide

SONOS



SUB

THIS DOCUMENT CONTAINS INFORMATION THAT IS SUBJECT TO CHANGE WITHOUT NOTICE.

No part of this publication may be reproduced or transmitted in any form or by any means, electronic or mechanical, including but not limited to photocopying, recording, information retrieval systems, or computer network without the written permission of Sonos, Inc. Sonos and all other Sonos product names and slogans are trademarks or registered trademarks of Sonos, Inc. Sonos Reg. U.S. Pat. & Tm. Off.

Sonos products may be protected by one or more patents. Our patent-to-product information can be found here:

sonos.com/legal/patents

iPhone®, iPod®, iPad®, Airplay®, iTunes®, OS X® and Apple Music™ are trademarks of Apple Inc., registered in the U.S. and other countries.

Windows® is a registered trademark of Microsoft Corporation in the United States and other countries.

Android™ is a trademark of Google, Inc.

Amazon, Kindle, Kindle Fire, the Amazon Kindle logo and the Kindle Fire logo are trademarks of Amazon.com, Inc. or its affiliates.

Sonos uses MSNTP software, which was developed by N.M. Maclaren at the University of Cambridge.

© Copyright, N.M. Maclaren, 1996, 1997, 2000; © Copyright, University of Cambridge, 1996, 1997, 2000.

All other products and services mentioned may be trademarks or service marks of their respective owners.

September 2016

©2004-2016 by Sonos, Inc. All rights reserved.

Sonos SUB

The Sonos SUB™ takes your audio experience to the next level when you add this wireless subwoofer to an existing Sonos room.

- Instantly adds a dimension of deep bass impact to your audio listening experience.
- Allows placement anywhere because it's wireless and compact—position it vertically or horizontally on any floor surface.

Note: The Sonos SUB is designed for use with any amplified Sonos player, including the PLAYBAR®, PLAY:1®, PLAY:3®, PLAY:5®, CONNECT:AMP™ or ZP100.

It is not designed for use with unamplified Sonos players, such as the CONNECT™ and ZP80.

New to Sonos?

Set up your Sonos Wireless HiFi System with at least one amplified Sonos player—PLAYBAR, PLAY:1, PLAY:3, PLAY:5, CONNECT:AMP, or ZP100 before adding the Sonos SUB to your music system. For help with this step, refer to the instructions packaged with your other Sonos products.

Once you've set up your music system, you can add additional Sonos products any time (up to 32).

Adding to an Existing Sonos System?

Sonos can be easily expanded room by room. See **Adding the SUB to Sonos** for more information.



The Sonos App

You can use the free Sonos app with any compatible device, including:

- **Sonos app (Android)**—Android 4.0 and higher; certain features require later versions.
Touch the **Play Store** or **Market** button on your Android device to download the free Sonos app from Google Play.
- **Sonos app (iOS)**—iPhone, iPad and iPod touch running iOS 8.0 or later; certain features may require later versions.
Touch the **App Store** button on your iPhone, iPod touch or iPad to download the free Sonos app, or download the application from iTunes®. (If you download from iTunes, you will need to sync before you see the Sonos logo display on your device.)
- **Sonos app (PC)**—Windows® 7 and higher; certain features require later versions.
Download from our website at www.sonos.com/support/downloads.
- **Sonos app (Mac)**—Macintosh® OS X 10.9 or later
Download from our website at www.sonos.com/support/downloads.

Note: Sonos CONTROL has been discontinued, but it's compatible with your new Sonos product.

SUB Bottom/Side

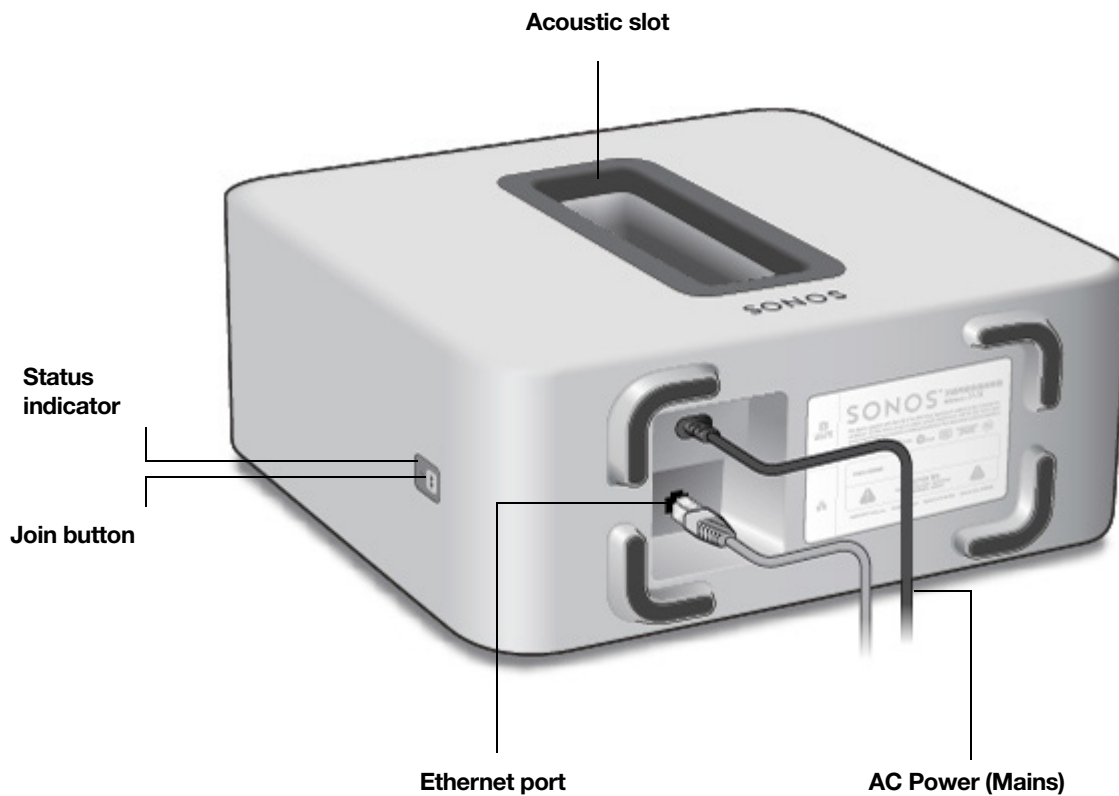

Join button	Press the Join button to associate the SUB with your Sonos Wireless HiFi System.
Acoustic slot	The top of the acoustic slot doubles as a handle so you can lift it. SUB placement: Make sure at least one side of the slot is free from obstruction. If you place it vertically against a wall, do not block the front opening. If you place the SUB horizontally on the floor, don't put anything on top of it.
SUB status indicator	LED indicates the SUB status. • For a complete list of status indicators, please go to http://faq.sonos.com/led .
Ethernet port	Use an Ethernet cable to connect the SUB to your home network.
AC power (mains) input	Use only the supplied power cord to connect to a power outlet (using a third party power cord will void your warranty). Be sure to use the proper power adapter for your country. <i>Push the power cord firmly into the SUB until it is flush with the surface.</i>

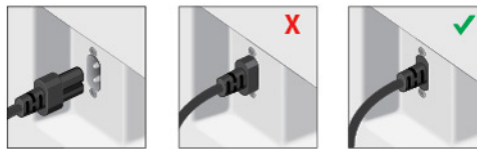

Adding the SUB to Sonos

You can easily add the Sonos SUB to an existing Sonos system.

- You can pair the SUB with any amplified Sonos player, including a PLAYBAR, CONNECT:AMP, PLAY:1, PLAY:3, PLAY:5, or ZP100. You cannot associate it with an un-amplified Sonos player such as the CONNECT or ZP80.
- The SUB is compatible with Sonos software versions 3.8 and later. **Be sure to check for software updates before adding the SUB to Sonos.**

1. Carefully unpack the package contents.

Caution: Subwoofers are heavy. Exercise caution when unpacking your Sonos SUB. Use the acoustic slot as a handle to lift the SUB out of the box. (You should always bend your knees when lifting heavy objects to avoid undue stress on your back.)

2. Choose a location for the SUB. It is designed to provide optimal sound wherever you place it.
 - You can position the SUB either vertically or horizontally. If you are going to use the SUB horizontally on a smooth floor, you can attach the 4 permanent felt feet (included with your SUB) to each of the corners.

See **Attaching the feet for horizontal placement** for more information.

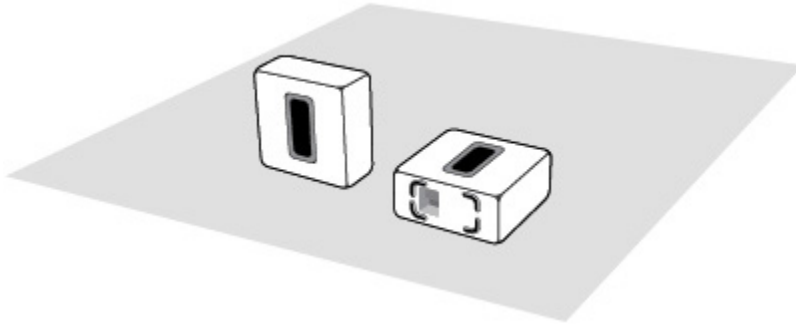

Make sure at least one side of the rectangular opening (acoustic slot) is unobstructed.

- If you place the SUB vertically flush against a wall, do not block the front acoustic slot.
- If you place the SUB horizontally on the floor, don't put anything on top of it. Leave at least 1" clearance along the top of the SUB if placing under furniture.

- The SUB is designed to be located on the floor. You can place it in a corner, against the wall, behind, under, or next to any piece of furniture on any kind of floor surface.

Note: The SUB contains strong magnets. Don't place the SUB near equipment that is sensitive to magnetic fields.

3. Attach the power adapter and plug in the SUB. *Be sure to push the power cord firmly into the SUB until it is flush with the surface.*



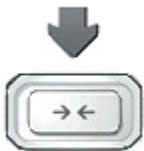

4. Choose one of the following options:
 - Using the Sonos app on a mobile device: Select **Add a Player or SUB** from the **Settings** menu.
 - Using the Sonos app on a Mac or PC: Select **Add a Player or SUB** from the **Manage** menu.



Press and release the **Join** button on the side of the SUB. The indicator flashes green and white while the SUB is connecting

To optimize your SUB's performance, during the setup process you will be prompted to make some choices—

- If you are joining a CONNECT:AMP or ZP100, select the size of your stereo speakers (Compact, Bookshelf/Ceiling or Floor.)
- Press Play  to compare the volume of two test sounds, A and B, and then select **No Difference, A is louder** or **B is louder**.
- Press Play  to listen to a test sound, and then select the best level for the SUB.

You may be prompted to update the SUB after you add it to Sonos.

Note: After the SUB is associated with a Sonos player, you will not see it displayed separately in the **Rooms** menu. Any changes you make to that Sonos player (volume, mute, music selection) will also affect the SUB.

Attaching the feet for horizontal placement

If you are going to use your SUB placed horizontally on a smooth floor, the Sonos SUB includes four (4) permanent felt feet you can attach to the corners of the unit. If you are laying the SUB down on a rug or using it vertically, there's no need to adhere the felt feet.

Note: The felt feet are not adjustable—a strong adhesive will keep them permanently attached to the SUB once you apply them.

The Sonos logo appears on the front of the SUB—you will adhere the felt feet to the opposite side of the unit.

1. Lay the SUB down on a rug or on top of the SUB's felt packing bag so the Sonos logo is facing down and is not visible.

2. Place the enclosed guide on one corner of the unit and fold the flaps over the edge.

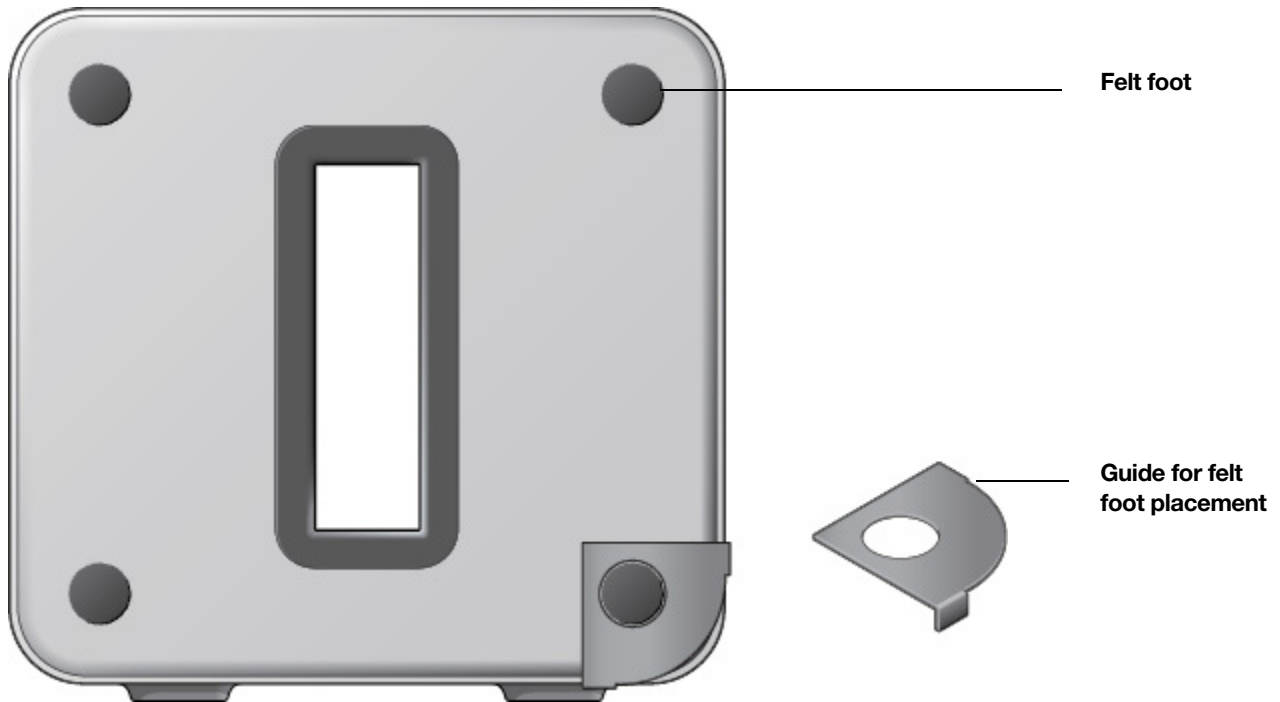

3. Peel the backing off one of the feet.
4. Press the felt foot (sticky side down) onto the unit inside the circular portion of the guide.
5. Repeat this process for the other three (3) corners.

SUB Settings

The SUB's settings are determined during the initial setup process. If you wish to make changes, follow the steps below to adjust how the SUB works with the associated Sonos product or stereo pair.

Changing SUB Settings

Using the Sonos app on a mobile device

1. Select **Settings** -> **Room Settings**.
2. Select the room that is associated with the Sonos SUB. It appears as *Room (+SUB)* on the **Room Settings** menu.
3. Select **Advanced Audio** -> **SUB Settings**.
4. Choose one of the following options:
 - **SUB:** Choose **On** or **Off** to turn the sound from the SUB on and off.
 - **SUB Level Adjustment:** Use the slider to increase or decrease the volume of the SUB. (You can use this setting to match the subwoofer level to the level of your main speakers.)
 - **Placement Adjustment (phase):** Select **On** or **Off**.
 - **Speaker Size Adjustment (Crossover):** This setting only appears when the SUB is associated with a CONNECT:AMP or ZonePlayer 100. *You may wish to choose a different setting from the list if:*
 - the main speakers sound distorted at high volumes—moving to a smaller speaker size setting can help.
 - your attention is drawn to the SUB's location while listening to music—moving to a larger speaker size setting can help.

1	Compact	110 Hz
2		100 Hz
3		90 Hz
4	Bookshelf / Ceiling	80 Hz
5		70 Hz
6	Floor	60 Hz
7		50 Hz

Using the Sonos app on a Mac or PC

1. Select **Manage** -> **Settings** (PC) or **Sonos** -> **Preferences** (Mac).
2. Select **Room Settings**.
3. Select the room that is associated with the Sonos SUB. It appears as *Room (+SUB)* on the **Room Settings** menu.
4. Select the **SUB** tab.

5. Choose one of the following options:



- **SUB:** Check to turn the sound from the SUB on; uncheck to turn it off.
- **SUB Level Adjustment:** Use the slider to increase or decrease the volume of the SUB. (You can use this setting to match the subwoofer level to the level of your main speakers.)
- **Placement Adjustment (phase):** Check or uncheck the box to adjust the phase.
- **Speaker Size Adjustment (Crossover):** This setting only appears when the SUB is associated with a CONNECT:AMP or ZonePlayer 100. *You may wish to choose a different setting from the drop-down list if:*
 - the main speakers sound distorted at high volumes—moving to a smaller speaker size setting can help.
 - your attention is drawn to the SUB's location while listening to music—moving to a larger speaker size setting can help.

1	Compact	110 Hz
2		100 Hz
3		90 Hz
4	Bookshelf / Ceiling	80 Hz
5		70 Hz
6	Floor	60 Hz
7		50 Hz

Recalibrating the SUB



After initial setup, you may wish to make some adjustments to optimize your SUB's performance. If you move the SUB to another location, purchase new speakers, or simply want to adjust the sound, follow the steps below to recalibrate the SUB.

Using the Sonos app for Android

1. Select **Settings -> Room Settings**.
2. Select the room that is associated with the Sonos SUB. It appears as *Room (+SUB)* on the **Room Settings** menu.
3. Select **Advanced Audio -> Recalibrate SUB**.
4. Follow the prompts to optimize your SUB's performance:
 - Select the size of your stereo speakers (CONNECT:AMP or ZP100 only).
 - Press Play  to compare the volume of two test sounds, A and B, and then select **No Difference**, **A is louder** or **B is louder**.
 - Press Play  to listen to a test sound, and then select the level you prefer.

Using the Sonos app on a Mac or PC

1. Select **Manage -> Settings (PC)** or **Sonos -> Preferences (Mac)**.
2. Select **Room Settings**.

3. Select the room that is associated with the Sonos SUB. It appears as *Room (+SUB)* on the **Room Settings** menu.
4. Select the **Basic** tab, and then select **Recalibrate SUB**.
5. Follow the prompts to optimize your SUB's performance:
 - Select the size of your stereo speakers (CONNECT:AMP or ZP100 only).
 - Press Play  to compare the volume of two test sounds, A and B, and then select **No Difference**, **A is louder** or **B is louder**.
 - Press Play  to listen to a test sound, and then select the level you prefer.

Changing the SUB's Room Association

You can easily associate the SUB with a different Sonos player (CONNECT:AMP, PLAY:1, PLAY:3, PLAY:5, PLAYBAR, or ZP100).

If you are moving the SUB to a new room, first unplug the SUB, locate it on the floor in another room, and then plug it back in. The status light on the side of the SUB will begin to flash. Once it lights solid again, you are ready to proceed.

Using the Sonos app on a mobile device

1. Select **Settings** -> **Room Settings**.
2. Select the room that is currently associated with the Sonos SUB. It appears as *Room (+SUB)* on the **Room Settings** menu.
3. Select **Remove SUB**.
4. Choose one of the following settings:
 - If you want to associate the SUB with a different Sonos player, select **Choose Room for SUB** and then select another room.
 - If you are not going to use the SUB right now, select **Don't use SUB**. It will appear on the **Rooms** menu as *SUB (unused)* until you select it and associate it with another Sonos player.

Using the Sonos app on a Mac or PC

1. Select **Manage** -> **Settings** (PC) or **Sonos** -> **Preferences** (Mac).
2. Select **Room Settings**.
3. Select the room that is associated with the Sonos SUB. It appears as *Room (+SUB)* on the **Room Settings** menu.
4. From the **Basic** tab, select **Remove SUB**.
5. Choose one of the following settings:
 - If you want to associate the SUB with a different Sonos player, select **Choose Room for SUB** and then select another room.
 - If you are not going to use the SUB right now, select **Don't use SUB**. It will appear on the **Rooms** menu as *SUB (unused)* until you select it and associate it with another Sonos player.

LED Explanations

Indicator Lights	Player State	Sonos Product	Additional Information
Flashing white	Powering up	BRIDGE, BOOST, CONNECT, SUB, CONNECT:AMP, DOCK, PLAY:1, PLAY:3, PLAY:5, PLAYBAR	
Solid white <i>(dimly lit)</i>	Powered up and associated with a Sonos system (normal operation)	BRIDGE, BOOST, CONNECT, SUB, CONNECT:AMP, DOCK, PLAY:1, PLAY:3, PLAY:5, PLAYBAR	If desired, when the product is in normal operation, you can turn the white status indicator light on or off from Room Settings . (The SUB and any players set to surround reflect the same setting as the player they are paired with.)
Solid white <i>(brightly lit)</i>	Touch control(s) active	PLAY:5 (gen2)	Brightens when touch controls are activated and remains at full brightness for the duration of contact.
Flashing green	Powered up, not yet associated with a Sonos system <i>Or,</i> WAC (wireless access configuration) join ready	BRIDGE, BOOST, CONNECT, SUB, CONNECT:AMP, DOCK, PLAY:1, PLAY:3, PLAY:5, PLAYBAR	For a SUB, this may indicate the SUB is not yet paired with a player.
Slowly flashing green	Surround audio is off or SUB audio is off	PLAY:1, PLAY:3, PLAY:5 (gen2), SUB	Applicable for player configured as a PLAYBAR surround speaker, or for a SUB paired with a PLAYBAR
Solid green	Volume set to zero or muted	CONNECT, CONNECT:AMP, PLAY:1, PLAY:3, PLAY:5, PLAYBAR	
Flashing orange	During SonosNet setup, this occurs after a button press while the product is searching for a household to join.	BRIDGE, BOOST, CONNECT, SUB, CONNECT:AMP, DOCK, PLAY:1, PLAY:3, PLAY:5, PLAYBAR	

Indicator Lights	Player State	Sonos Product	Additional Information
Rapidly flashing orange	Playback / Next Track failed	CONNECT, CONNECT:AMP, PLAY:1, PLAY:3, PLAY:5, PLAYBAR	Indicates either playback or next track was not possible
Solid orange	During wireless setup, this occurs while the Sonos open access point is temporarily active. If you are not setting up Sonos, this may indicate warning mode.	CONNECT, SUB, CONNECT:AMP, PLAY:1, PLAY:3, PLAY:5, PLAYBAR	If the orange light is on AND the player's volume level automatically reduces, this indicates the player is in warning mode. <ul style="list-style-type: none"> • Press the Pause button to stop the audio • For Sonos products with a vent opening (SUB, CONNECT:AMP), check to make sure it's not blocked • Check the room temperature to make sure it's less than 104°F/ 40° C • If the player is in direct sunlight, provide shade • Allow the player to cool for several minutes and then press Play to restart the audio • If the problem does not resolve, please contact Customer Support

Important Safety Information

Warning: Under no circumstances should the product be repaired by anyone other than an authorized Sonos repair center, as this will invalidate the warranty. Please contact Sonos Customer Support for more information. Do not open the system as there is a risk of electric shock.

1. Read these instructions.
2. Keep these instructions.
3. Heed all warnings.
4. Follow all instructions.
5. Do not use this apparatus near water.
6. Clean only with dry soft cloth. Household cleaners or solvents can damage the finish on your Sonos products.
7. Do not install near any heat sources such as radiators, heat registers, stoves, or other apparatus that produce heat.
8. Protect the power cable from being walked on or pinched, particularly at plugs, convenience receptacles, and the point where they exit from the apparatus.
9. Only use attachments/accessories specified by the manufacturer.

10. Unplug this apparatus during lightning storms or when unused for long periods of time.
11. Refer all servicing to Sonos qualified service personnel. Servicing is required when the apparatus has been damaged in any way, such as power-supply cable or plug is damaged, liquid has been spilled or objects have fallen into the apparatus, the apparatus has been exposed to rain or moisture, does not operate normally, or has been dropped.
12. The Mains plug should be readily available to disconnect the equipment.
13. **Warning:** To reduce the risk of fire or electric shock, do not expose this apparatus to rain or moisture.
14. Do not expose apparatus to dripping or splashing and do not place objects filled with liquids, such as vases, on the apparatus.

Caution: Do not sit or stand on the SUB. It could tip over resulting in personal injury.

Specifications

Feature	Description
Audio	
Amplifier	Two Class-D digital amplifiers
Speakers	Two force-cancelling speakers positioned face-to-face for deeper, richer sound and zero cabinet buzz or rattle.
Dual Acoustic Ports	Tuned to enhance the SUB performance.
Frequency Response	Plays down to 25 Hz.
All Digital Sound	All filter settings, active equalization, and time alignment are done digitally through state-of-the-art DSP (Digital Signal Processing) circuitry for zero-loss audio quality and energy.
Automatic Equalization	The system automatically adjusts audio settings across all connected components.
Networking	
Ethernet Port	One Ethernet port that can connect the SUB to a wired home network.
Wireless Connectivity	Connects to your home WiFi network with any 802.11 b/g/n router.
SonosNet™ Extender	Functions to extend and enhance the power of SonosNet, a secure AES encrypted, peer-to-peer wireless mesh network dedicated exclusively for Sonos to reduce WiFi interference.
General	

Feature	Description
Side Panel Button (Join Button)	Join household
Side Panel LEDs	Indicate SUB status
Power Supply	100 - 240 VAC, 50/60 Hz, auto-switchable
Dimensions (H x D x W)	15.3 x 6.2 x 15.8in. (389 x 158 x 402mm)
Weight	36.3 lbs (16kgs)
Operating Temperature	32°F to 104°F (0°C to 40°C)
Storage Temperature	4°F to 158°F (-20°C to 70°C)
Multiple Orientations	Stand upright or lay flat for flexible placement.
Rubber and Felt Feet	Built-in rubber feet; optional felt feet included.
Supported Devices	SUB works with all Sonos amplified products: CONNECT:AMP; PLAY:5; PLAY:3; PLAY:1; PLAYBAR; ZP100 Does not work with the non-amplified Sonos CONNECT or ZP80.

* Specifications subject to change without notice.

Need More Help?

- Visit our Frequently Asked Questions (FAQ) pages at www.sonos.com/support.
- Ask us a question at <http://www.sonos.com/emailsupport>.

Submit Feedback

We'd love to hear from you! Send us feedback on our guides at: docfeedback@sonos.com